

# PRECISION 2.5 VOLT MICROPPOWER VOLTAGE REFERENCE

# ZR25D

ISSUE 2 - FEBRUARY 1998

## DEVICE DESCRIPTION

The ZR25D uses a bandgap circuit design to achieve a precision micropower voltage reference of 2.5 volts. The device is available in a small outline SOT23 surface mount package, ideal for applications where space saving is important.

The ZR25D design provides a stable voltage without an external capacitor and is stable with capacitive loads. The ZR25D is recommended for operation between 50 $\mu$ A and 5mA and so is ideally suited to low power and battery powered applications.

Excellent performance is maintained to an absolute maximum of 25mA, however the rugged design and 20 volt processing allows the reference to withstand transient effects and currents up to 200mA. Superior switching capability allows the device to reach stable operating conditions in only a few microseconds.

## FEATURES

- Small outline SOT23 package.
- No stabilising capacitor required
- Typical  $T_C$  30ppm/ $^{\circ}C$
- Typical slope resistance 0.4 $\Omega$
- $\pm 3\%$ , 2% and 1% tolerance
- Industrial temperature range
- Operating current 50 $\mu$ A to 5mA
- Transient response, stable in less than 10 $\mu$ s
- Alternative package options available

## APPLICATIONS

- Battery powered and portable equipment.
- Metering and measurement systems.
- Instrumentation.
- Test equipment.
- Data acquisition systems.
- Precision power supplies.

## SCHEMATIC DIAGRAM

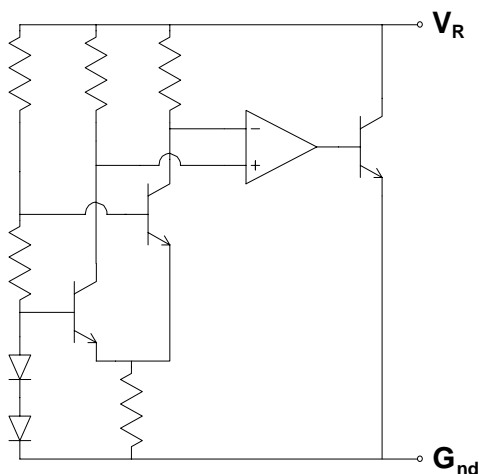

# ZR25D

## ABSOLUTE MAXIMUM RATING

Reverse Current	25mA
Forward Current	25mA
Operating Temperature	-40 to 85°C
Storage Temperature	-55 to 125°C

## Power Dissipation (T<sub>amb</sub>=25°C)

SOT23 330mW

## ELECTRICAL CHARACTERISTICS

### TEST CONDITIONS (Unless otherwise stated) T<sub>amb</sub>=25°C

SYMBOL	PARAMETER	CONDITIONS	LIMITS			TOL. %	UNITS
			MIN	TYP	MAX		
V <sub>R</sub>	Reverse Breakdown Voltage	I <sub>R</sub> =150μA	2.475 2.45 2.425	2.5 2.5 2.5	2.525 2.55 2.575	1 2 3	V
I <sub>MIN</sub>	Minimum Operating Current			25	50		μA
I <sub>R</sub>	Recommended Operating Current		0.05		5		mA
T <sub>C</sub> †	Average Reverse Breakdown Voltage Temp. Co.	I <sub>R(min)</sub> to I <sub>R(max)</sub>		30	90		ppm/°C
R <sub>S</sub> §	Slope Resistance			0.4	2		Ω
Z <sub>R</sub>	Reverse Dynamic Impedance	I <sub>R</sub> = 1mA f = 100Hz I <sub>AC</sub> =0.1 I <sub>R</sub>		0.3	0.8		Ω
E <sub>N</sub>	Wideband Noise Voltage	I <sub>R</sub> = 150μA f = 100Hz to 10kHz		45			μV(rms)

$$\dagger T_C = \frac{(V_{R(max)} - V_{R(min)}) \times 1000000}{V_R \times (T_{(max)} - T_{(min)})}$$

Note: V<sub>R(max)</sub> - V<sub>R(min)</sub> is the maximum deviation in reference voltage measured over the full operating temperature range.

$$\S R_S = \frac{V_R \text{ Change}(I_R(\min) \text{ to } I_R(\max))}{I_R(\max) - I_R(\min)}$$

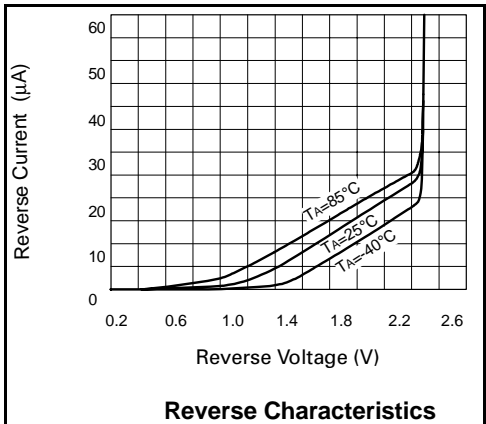

## TYPICAL CHARACTERISTICS

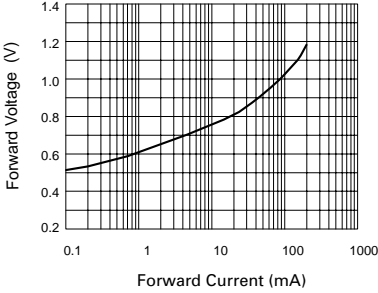

**Forward Characteristics**

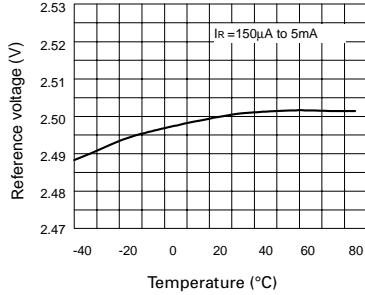

**Temperature Drift**

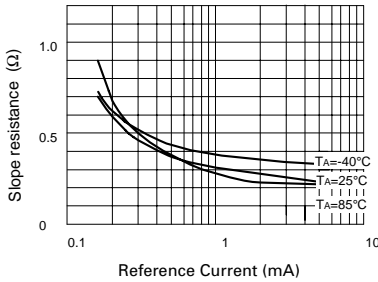

**Slope Resistance v Current**

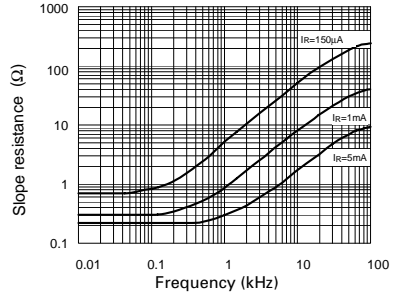

**Slope Resistance v Frequency**

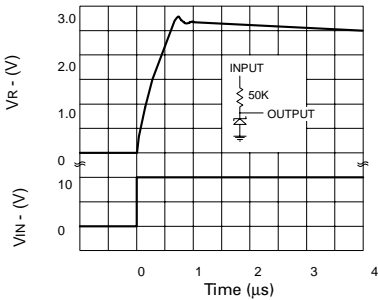

**Transient Response ( $I_R = 150\mu\text{A}$ )**

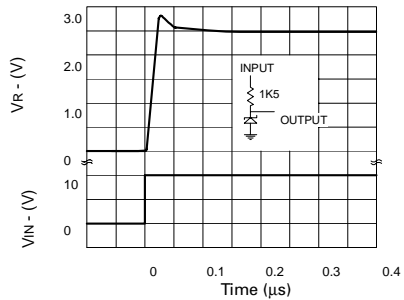

**Transient Response ( $I_R = 5\text{mA}$ )**

# ZR25D

## CONNECTION DIAGRAMS

### SOT23

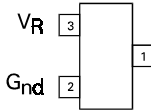

*Top View –  
pin 1 floating or connected  $G_{nd}$*

## ORDERING INFORMATION

Part No	Tol%	Package	Partmark
ZR25D	3	SOT23	25N
ZR25D02	2	SOT23	25P
ZR25D01	1	SOT23	25R